



**WORLD'S BEST
ALLOY BULLBARS**

East Coast Bullbars (ECB Pty Ltd)

Tel: 07 3897 5700

Fax: 07 3283 1168

ecb@ecb.com.au www.ecb.com.au

29 Snook St
Clontarf QLD 4019
Australia

Po Box 122
Margate QLD 4019
Australia

NB6K06SY / NBK06SY

REPLACES: 15.09.17
REVISED: 25.03.21

FITTING INSTRUCTIONS

KIA SPORTAGE MY17on 63mm SERIES 2 NUDGE BAR AND 76mm NUDGE BAR VEHICLE FRONTAL PROTECTION SYSTEM (VFPS) FOR AIR BAG & ADR COMPLIANT VEHICLES

Check installation hardware before commencing.

Caution needs to be taken when unclipping bumper from guard. A small screwdriver will need to be used to stop bumper skin from ripping from mount.

1. Park the vehicle on level ground and apply the hand brake. Lift bonnet.
2. Remove two 10mm hex head screws and four push pull clips from the top of the grill. **See figure 1.**
3. To remove the underbody guard release four 10mm head screws. Remove from the vehicle and store for refitting.
4. Remove one 10mm head screw and three push pull clips from the wheel arch (each side). Pull out on the rear of the bumper bar wing to un-clip the retainer. Remove the headlight washer unit from each side. Disconnect the light and parking sensor plugs and pull forward to access clips under the grill near the headlight (each side), release the clips and remove bumper from the vehicle. **See figure 2.**
5. Remove the lower plastic grill from the vehicle. Retain for refitting.
6. Remove three 10mm head bolts retaining the plastic air dam located below the radiator. Trim the upper section of plastic air dam away to allow clearance for the chassis mount. Measure 70mm from the top. **See figure 3.**
7. Place the Steel mounting brackets (supplied) onto the front of the impact member and lightly fasten using M10 x 70 x 1.5 bolts, flat washers, spring washers and nuts (supplied) from rear through chassis mount backing plates (supplied). Align the mounts centrally and tighten all fasteners.
Note: Bolt heads must be at the radiator side of the mounts. See figure 4.
8. Remove the two centre parking sensors from the rear of the bumper. **See figure 5.**
9. Carefully cut the parking sensor wires and extend using the supplied wire extenders and joiners. **See figure 6.**
10. Route the extended parking sensor wiring out through the vent area and cover with 10mm split loom (supplied). **See figure 7.**
11. Trim the lower grill so the chassis mounts will protrude through when refitted. **See figure 8.**
12. Attach the parking sensors to the nudge bar parking sensor mounts and secure using cable ties. (Do not over tighten the cable ties) **See figure 9.**
13. Refit bumper to vehicle as per reverse of steps 2 to 4. Be sure all original fasteners are refitted.
14. Re-connect the park lights and connect the parking sensor wiring.



East Coast Bullbars (ECB Pty Ltd)

Tel: 07 3897 5700

Fax: 07 3283 1168

ecb@ecb.com.au www.ecb.com.au

29 Snook St
Clontarf QLD 4019
Australia

Po Box 122
Margate QLD 4019
Australia

WORLD'S BEST
ALLOY BULLBARS

15. Fit the nudge bar outside the chassis mounts and lightly fasten using four M10 x 40 x 1.5 bolts, flat washers, spring washers and nuts (supplied). **See figure 10.**
16. Align the nudge bar with the vehicle, tighten all fasteners and connect the parking sensors. **See figures 11 and 12 for Nudge Bar and figures 14 and 15 for Series 2 Nudge Bar.**
17. Check the operation of all lights and parking sensors etc.

ENSURE NUMBER PLATE IS CLEARLY VISABLE

Note: When fitting/refitting the licence plate to the vehicle, ensure there is no obstruction to licence plate vision in accordance with local authorities. If required relocate licence plate to an alternate location.

Further VFPS Notes:

- a) Do not attach VFPS to the vehicle using anchorages not intended for this purpose (e.g. engine mounting bolts).
- b) Do not use this product for any vehicle make or model, other than those specified by the VFPS manufacturer.
- c) Do not remove the plaque or label from the VFPS.
- d) Do not modify the structure of the VFPS in any way.
- e) No accessory or fitment should project forward of the VFPS forward profile.
- f) **ENSURE THESE INSTRUCTIONS ARE LEFT WITH VEHICLE OWNER AND/OR OPERATOR.**

IMPORTANT INFORMATION

Periodically check bolts and nuts for correct tightness, especially if travelling on rough roads.

1 – Pair Steel mounting brackets	12 – M10 x 1.5 nuts
4 – Chassis mount backing plates	12 – 0.5mm wire 400mm long
8 – M10 x 70 x 1.5mm hex bolts	24 – Soldier joiners
4 – M10 x 40 x 1.5mm bolts	2 – 10mm split loom 450mm long
24 – M10 x 25 flat washers	8 – 150mm Zip ties
12 – M10 spring washers	



Figure 1



Figure 2



East Coast Bullbars (ECB Pty Ltd)

Tel: 07 3897 5700

Fax: 07 3283 1168

ecb@ecb.com.au www.ecb.com.au

WORLD'S BEST
ALLOY BULLBARS

29 Snook St
Clontarf QLD 4019
Australia

Po Box 122
Margate QLD 4019
Australia



Figure 3

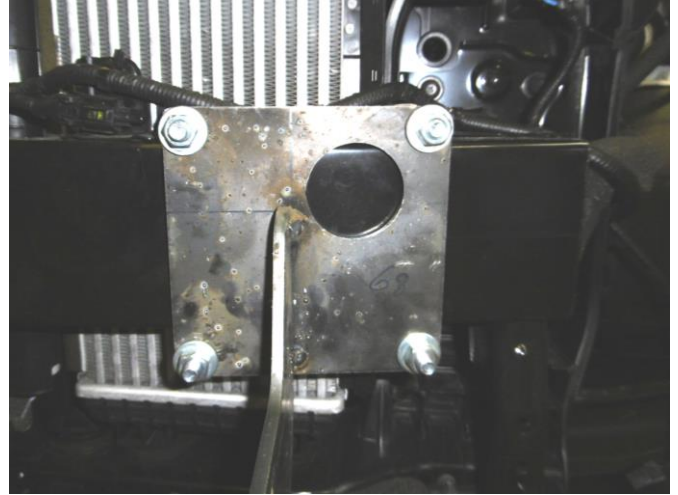

Figure 4



Figure 5

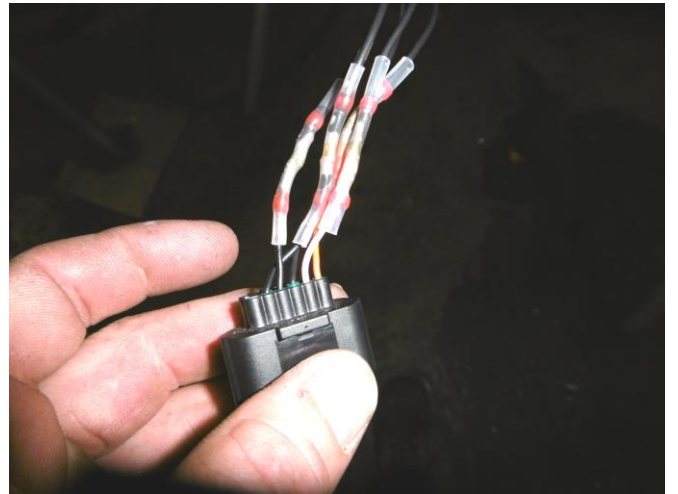

Figure 6

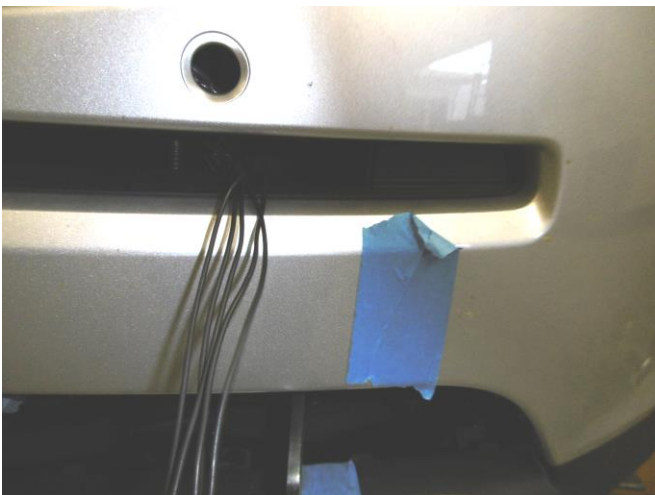

Figure 7

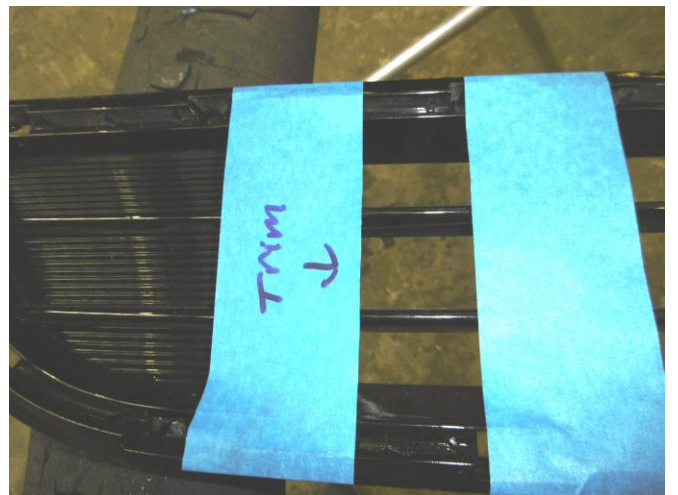

Figure 8



East Coast Bullbars (ECB Pty Ltd)

Tel: 07 3897 5700

Fax: 07 3283 1168

ecb@ecb.com.au www.ecb.com.au

29 Snook St
Clontarf QLD 4019
Australia

Po Box 122
Margate QLD 4019
Australia

WORLD'S BEST
ALLOY BULLBARS



Figure 9



Figure 10



Figure 11



Figure 12



Figure 13



Figure 14



**WORLD'S BEST
ALLOY BULLBARS**

East Coast Bullbars (ECB Pty Ltd)

Tel: 07 3897 5700

Fax: 07 3283 1168

ecb@ecb.com.au www.ecb.com.au

29 Snook St
Clontarf QLD 4019
Australia

Po Box 122
Margate QLD 4019
Australia

We value your comments

Dear Fitter,

ECB would like to know how you went with the installation of this product. We value your comment and may need to contact you to clarify some details so please complete your contact details clearly.

We would appreciate if you could complete as many of the following details as possible.

Your Name:	Your contact No.
Product Part No.	Product Invoice No.
Product Description:	Make, model, and year of vehicle:
Product Work Order No.	Company your from/Company product purchased from:

Date of Fitment: ____/____/____

Was the fitting hardware supplied complete?

Yes

No

If no what was not supplied

Did the installation go well?

Yes

No

Please provide comments

Please draw diagrams if you need to.

Post to
Reply Paid 122
PO Box 122
Margate QLD 4019

Fax to
(07) 3283 1168



**WORLD'S BEST
ALLOY BULLBARS**

East Coast Bullbars (ECB Pty Ltd)

Tel: 07 3897 5700

Fax: 07 3283 1168

ecb@ecb.com.au www.ecb.com.au

29 Snook St
Clontarf QLD 4019
Australia

Po Box 122
Margate QLD 4019
Australia



WORLD'S BEST
ALLOY BULLBARS

East Coast Bullbars (ECB Pty Ltd)

Tel: 07 3897 5700

Fax: 07 3283 1168

ecb@ecb.com.au www.ecb.com.au

29 Snook St
Clontarf QLD 4019
Australia

Po Box 122
Margate QLD 4019
Australia

DESPATCH CHECKLIST NB6K06SY / NBK06SY

Work Order #		See other side of this page for photos of all mounts
Finish:		
Transport:		
Due Date:		

OC...1 – Pair Steel mounting brackets

BK...4 – Chassis mount plate Backing plates

BK...1 – Bolt Kit

WR...1 – Caution page regarding bumper removal attached to bar



Is this product “the best it can be” Yes _____ / _____
Wrapper’s initials / Checker initials

If **NO** fix before continuing

All parts checked and completed by:

Nut and bolts: _____ Date __/__/__

Order control: _____ Date __/__/__

Final wrap check: _____ Date __/__/__



East Coast Bullbars (ECB Pty Ltd)

Tel: 07 3897 5700

Fax: 07 3283 1168

ecb@ecb.com.au www.ecb.com.au

29 Snook St
Clontarf QLD 4019
Australia

Po Box 122
Margate QLD 4019
Australia

WORLD'S BEST
ALLOY BULLBARS

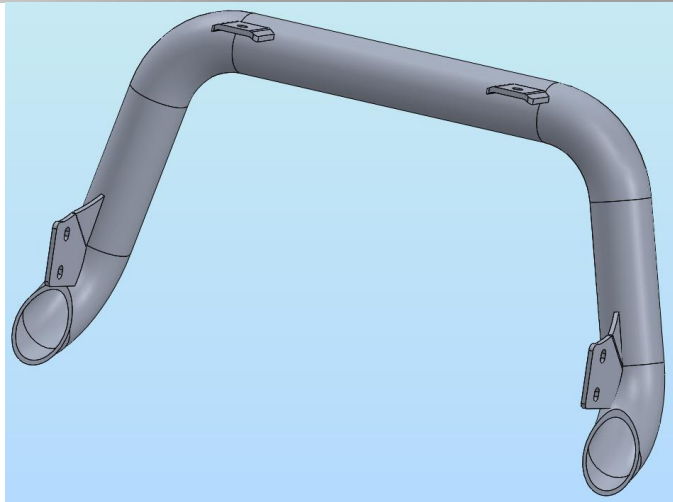

NBK06SY BULLBAR ASSEMBLY

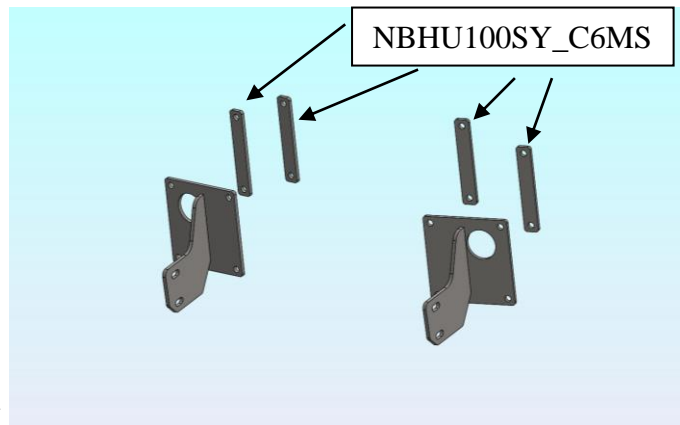

MOUNT ASSEMBLY SUITS NBK06SY & NB6K06SY

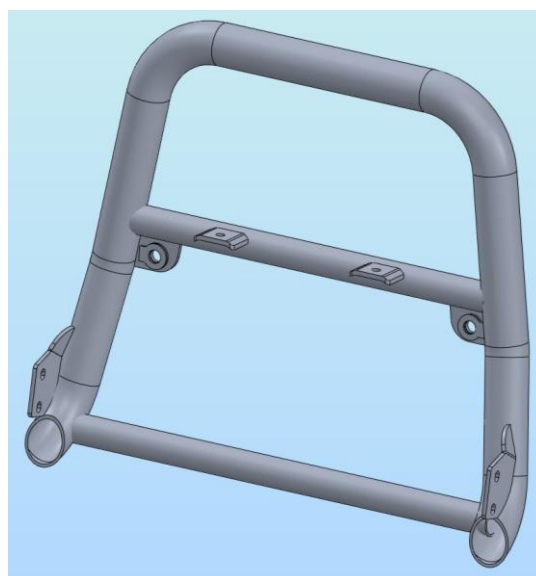

NB6K06SY BULLBAR ASSEMBLY



**WORLD'S BEST
ALLOY BULLBARS**

East Coast Bullbars (ECB Pty Ltd)

Tel: 07 3897 5700

Fax: 07 3283 1168

ecb@ecb.com.au www.ecb.com.au

29 Snook St
Clontarf QLD 4019
Australia

Po Box 122
Margate QLD 4019
Australia

WARNING

EXTREME

**CAUTION MUST
BE USED WHEN**

REMOVING

BUMPER FROM

**THIS VEHICLE. SEE
INSTRUCTIONS.**

CAUTION



**WORLD'S BEST
ALLOY BULLBARS**

East Coast Bullbars (ECB Pty Ltd)

Tel: 07 3897 5700

Fax: 07 3283 1168

ecb@ecb.com.au www.ecb.com.au

29 Snook St
Clontarf QLD 4019
Australia

Po Box 122
Margate QLD 4019
Australia



**WORLD'S BEST
ALLOY BULLBARS**

East Coast Bullbars (ECB Pty Ltd)

Tel: 07 3897 5700

Fax: 07 3283 1168

ecb@ecb.com.au www.ecb.com.au

29 Snook St
Clontarf QLD 4019
Australia

Po Box 122
Margate QLD 4019
Australia

WARNING

EXTREME

**CAUTION MUST
BE USED WHEN**

REMOVING

BUMPER FROM

**THIS VEHICLE. SEE
INSTRUCTIONS.**

CAUTION



**WORLD'S BEST
ALLOY BULLBARS**

East Coast Bullbars (ECB Pty Ltd)

Tel: 07 3897 5700

Fax: 07 3283 1168

ecb@ecb.com.au www.ecb.com.au

29 Snook St
Clontarf QLD 4019
Australia

Po Box 122
Margate QLD 4019
Australia